

KITO ERIKKILA



**PROSYSTEM
LIGHT CRANES**



WELCOME TO THE WORLD OF TOP QUALITY AND INNOVATIONS

KITO ERIKKILA PROSYSTEM LIGHT CRANE SOLUTIONS STAND FOR QUALITY, INNOVATION AND SAFETY

The history of KITO ERIKKILA dates back to 1912, when the company was founded in Vyborg, Finland. ERIKKILA got its first crane representation in 1933 and has concentrated solely on the lifting business since 1976 when it developed its' Prosystem light crane system.

KITO ERIKKILA was the first to develop a low headroom bridge construction and invent and patent an overload indicator for light crane systems. KITO ERIKKILA is part of the KITO Group.

KITO ERIKKILA's headquarters and production are in Masala, Southern Finland. All light crane solutions, jib cranes, and portal cranes are manufactured in Finland using European sourced raw materials. Stringent KITO Quality Standards guarantee the highest quality. More than 100 partners in 40 countries support customers on all continents.

KITO ERIKKILA's Prosystem light cranes are designed to meet the varied and demanding requirements of workstations and production lines that need up to 2,000 kg of lifting capacity.



Column Jib Crane (overbraced steel)

KITO ERIKKILA PRODUCT RANGE

Prosystem single and double girder cranes are user-friendly personal workstation cranes with extensive work area coverage. The cranes are easy to operate, enabling smooth transfer of loads.

Prosystem and Pro Compact jib cranes are versatile and durable workstation cranes with an option to fix the jib to a wall or floor mounted column. They help streamline production, assembly and maintenance and are suitable for most facilities.

Prosystem Portal cranes are easy to move from one workstation to another. They are best suited for occasional maintenance work in areas where a fixed crane is not available or possible to install.



Double Girder Crane
(aluminium bridge & steel track)



Double Girder Portal crane

PROSYSTEM LIGHT CRANE SOLUTIONS

EFFICIENT AND SAFE MATERIAL HANDLING

Prosystem single and double girder cranes are user-friendly personal workstation cranes with extensive work area coverage. The swinging of the load is minimised due to the smooth-running push trolley centralising the load automatically to the correct lifting position. The cranes are easy to operate, enabling quick, smooth, and safe handling of loads. The cranes can be ceiling-mounted or freestanding, single or double girder bridges.

Light crane solutions are modular and assembled from standard components. They make a perfect solution that can easily be configured to meet various lifting requirements in multiple industries. Operating the light crane system requires very little strength, making it safe and ergonomic. Cranes are lightweight yet powerful and can be installed on different ceiling types and suspension distances.

KITO ERIKKILA crane profiles have a world-class weight-load carrying capacity ratio. The steel profile ends are smoothened, and chamfered connection tubes guide the profiles together precisely and automatically to required tolerances. The joints are easy and fast to install and ensure lifetime alignment without further adjustments. The enclosed profile construction protects the trolley and internal power supply from dust and external impacts. All steel profiles are powder-coated to guarantee consistent and perfect surface treatment quality.

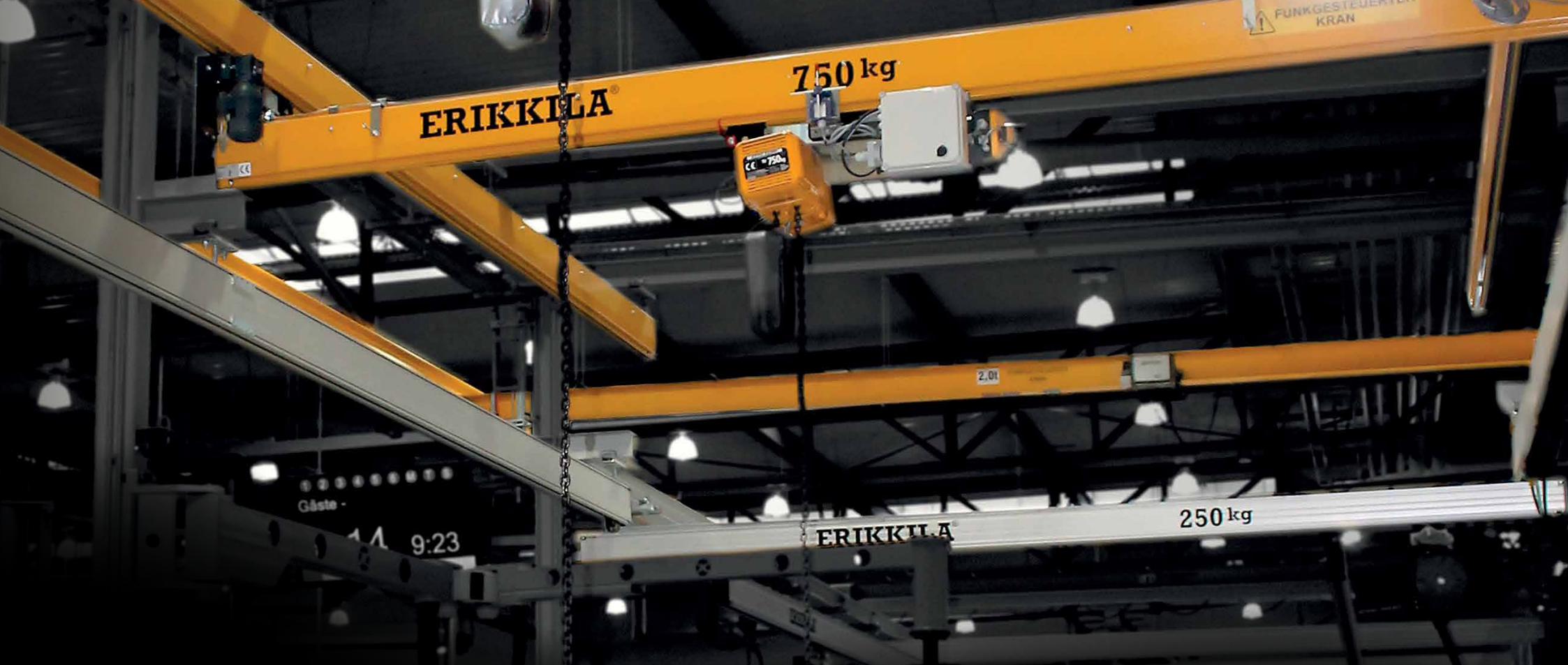

SINGLE AND DOUBLE GIRDER CRANES

The maximum load capacity of a single girder crane is 1500 kg, and of a double girder crane, 2000 kg. The double girder design increases the lifting height and the working area under the crane. The combination of steel and aluminium profiles provides a perfectly optimised solution for all lifting needs. The cranes can be manually operated or equipped with electrical movements for trolley and bridge, and they usually have an electric chain hoist for load lifting.

LOW HEADROOM CRANE

Single and double girder low headroom cranes are for applications with limited headroom to obtain maximum available lifting height. The bridge profile is raised between the tracks to optimise the lift height.

A PERFECT UNION OF STEEL AND ALUMINIUM

Strong (two types) aluminium profile joints that secure the profiles together

Trolley for steel profiles ensures minimum rolling resistance. Max. load 800 kg, steel body, integrated buffers, available with external guide wheels.

Optimised range of aluminium profiles that can take up to 500 kg upward forces with a standard trolley

Strong steel end plate with openings for internal conductor rail and flat cable power supply

Articulated bridge suspension ensures smooth crane operation

Current collector with guide wheels and optimally spring-loaded carbon brushes ensures light movements with minimum wear.

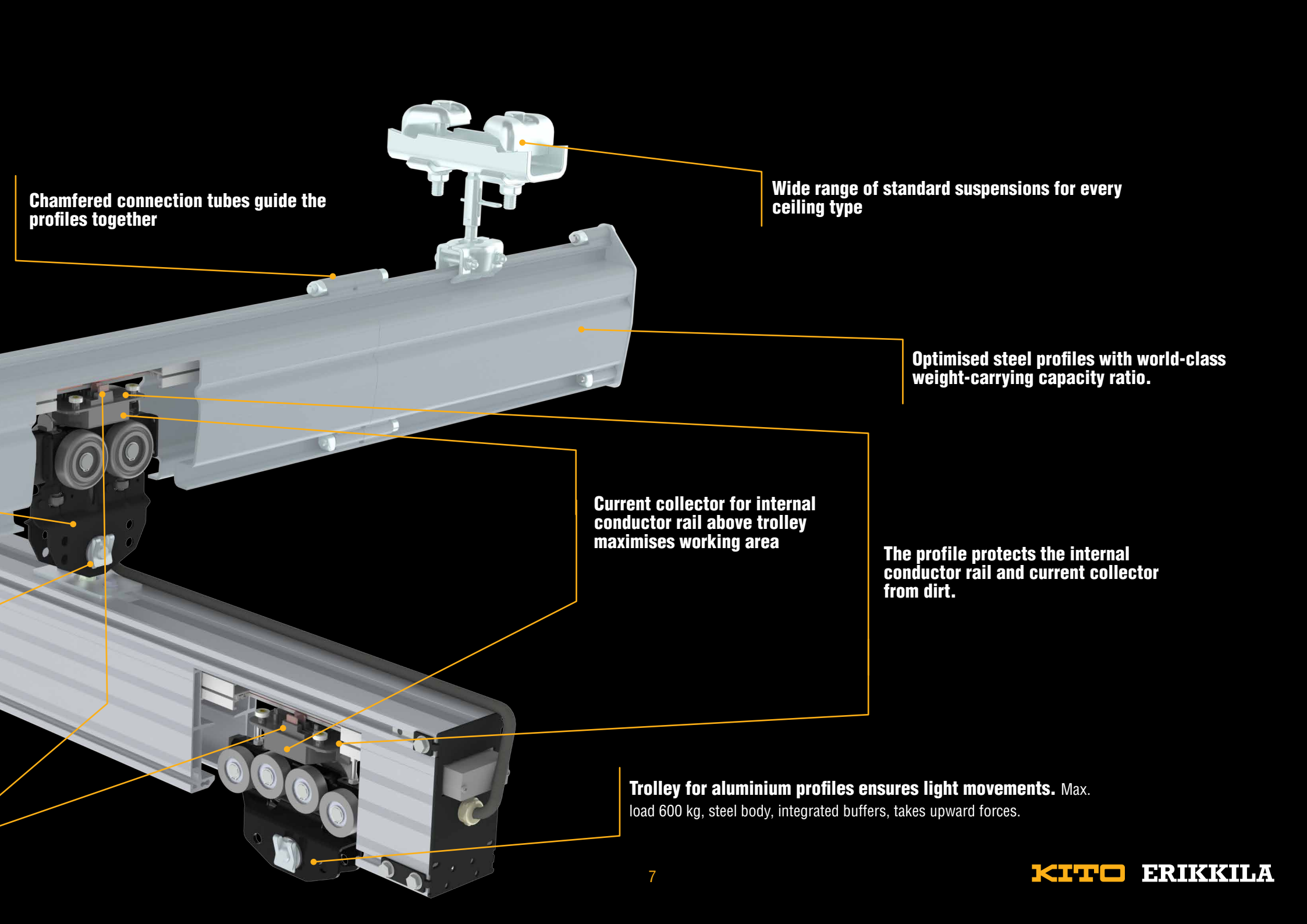

Chamfered connection tubes guide the profiles together

Wide range of standard suspensions for every ceiling type

Optimised steel profiles with world-class weight-carrying capacity ratio.

Current collector for internal conductor rail above trolley maximises working area

The profile protects the internal conductor rail and current collector from dirt.

Trolley for aluminium profiles ensures light movements. Max. load 600 kg, steel body, integrated buffers, takes upward forces.



PROSYSTEM MONORAILS

Monorails are suitable for long production lines and can be equipped with curves and tailored solutions like turntables and track switches. They can be manually operated or equipped with electrical movements for the trolley, and they usually have an electric chain hoist to lift the load.

Steel monorails up to 1250 kg capacity can be equipped with curves. The curves can be connected to other curves or straight profiles.



SINGLE TRACK (STEEL)

Standard range*:

Rated capacity... 50 – 1500 kg
Track..... 1 – 50 m
Hoisting..... 5 m



SINGLE TRACK (ALUMINIUM)

Standard range*:

Rated capacity... 50 – 1000 kg
Track..... 1 – 30 m
Hoisting..... 5 m



CURVED TRACK (STEEL)

Standard range*:

Rated capacity..... 50 – 1250 kg
Radius..... 1500 mm
Hoisting..... 5 m
Curves..... 15°, 30°, 45° (other available)

*Other options available as tailored solutions.

PROSYSTEM SINGLE AND DOUBLE GIRDER CRANES

Prosystem single and double girder cranes are user-friendly personal workstation cranes with extensive work area coverage. The swinging of the load is minimised due to the smooth-running push trolley centralising the load automatically to the correct lifting position. The cranes are easy to operate, enabling a smooth transfer of loads and boosting productivity when used.

Operating the light crane system requires minimal effort from the user, making it safe and ergonomic. The crane profiles are manufactured with a world-class weight-load carrying capacity ratio. Light crane solutions are modular and assembled from various standard components, and a solution can be configured for production lines in almost any industry.

The cranes can either be mounted to the ceiling or bolted to the floor with a freestanding support frame.

Single girder crane
(steel bridge and track)



Standard range*:
 Rated capacity... 50 – 1500 kg
 Span..... 2 – 8 m
 Track..... 4 – 50 m
 Hoisting..... 5 m

Single girder crane
(aluminium bridge and track)



Standard range*:
 Rated capacity... 50 – 1000 kg
 Span..... 2 – 7,8 m
 Track..... 4 – 30 m
 Hoisting..... 5 m

Double girder crane
(steel bridge and track)



Standard range*:
 Rated capacity... 125 – 2000 kg
 Span..... 2 – 8 m
 Track..... 4 – 40 m
 Hoisting..... 5 m

Double girder crane
(aluminium bridge and track)



Standard range*:
 Rated capacity... 125 – 1000 kg
 Span..... 2 – 7,8 m
 Track..... 4 – 30 m
 Hoisting..... 5 m

*Other options available as tailored solutions.



ERIKKILA

250kg

ERIKKILA

250kg

ERIKKILA

250kg

ERIKKILA®

1000 kg

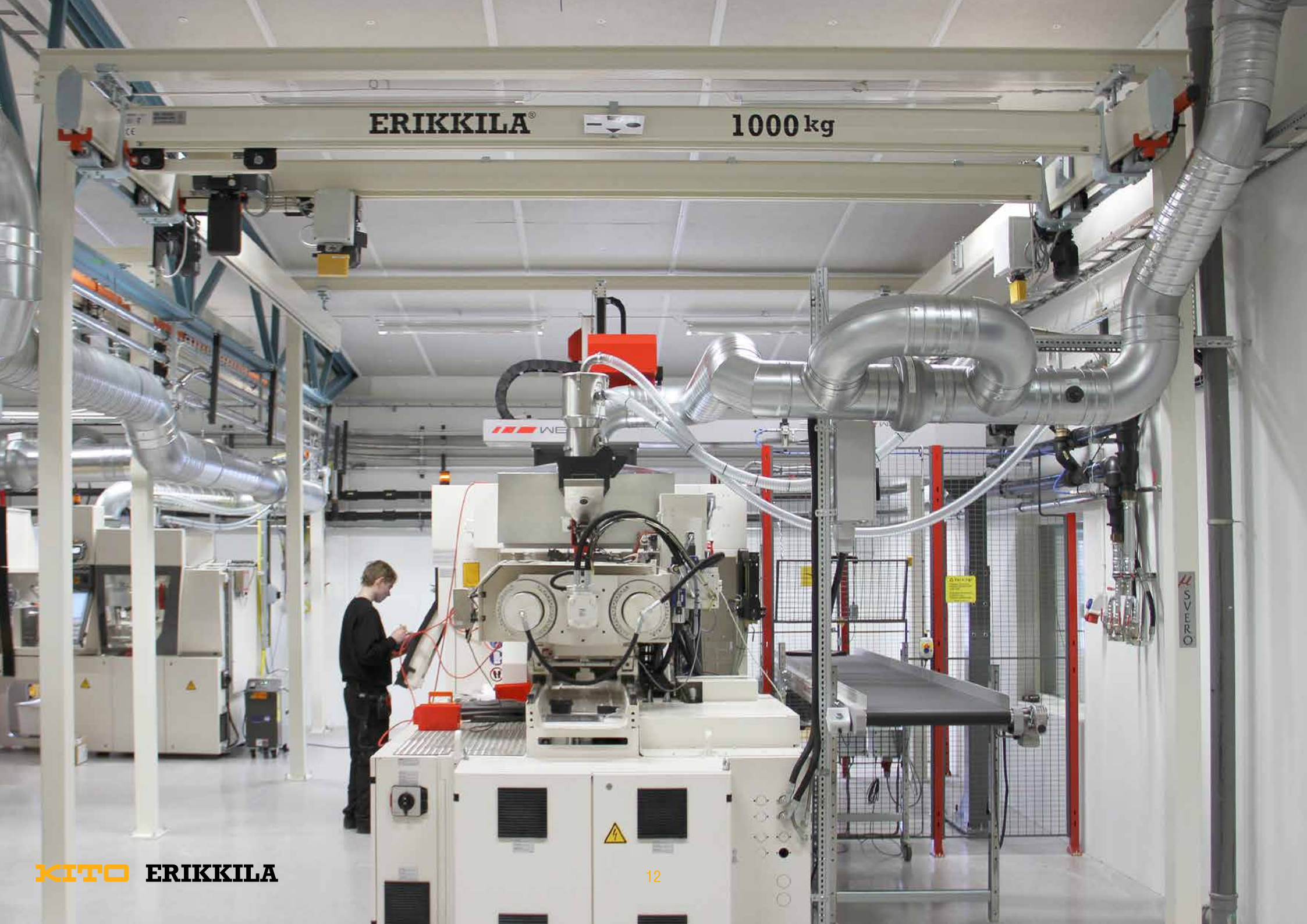

PROSYSTEM LOW HEADROOM CRANES

OPTIMISED DESIGN FOR MAXIMUM UTILISATION OF AVAILABLE LIFTING HEIGHT

Single and double girder low headroom cranes are the optimal solution in production lines with height restrictions or where there is limited space. The bridge profile is raised between the tracks to maximise the available lifting height.

Single girder crane
(steel bridge and track)



Standard range*:

Rated capacity... 50 – 1500 kg
Span..... 1 – 8 m
Track..... 4 – 50 m
Hoisting..... 5 m

Single girder crane
(aluminium bridge and track)



Standard range*:

Rated capacity... 50 – 1000 kg
Span..... 1 – 8 m
Track..... 4 – 30 m
Hoisting..... 5 m

Double girder crane
(steel bridge and track)



Standard range*:

Rated capacity... 125 – 2000 kg
Span..... 1 – 8 m
Track..... 4 – 40 m
Hoisting..... 5 m

Double girder crane
(aluminium bridge and track)



Standard range*:

Rated capacity... 125 – 1000 kg
Span..... 1 – 8 m
Track..... 4 – 30 m
Hoisting..... 5 m

*Other options available as tailored solutions.

PROFILES

**12 HIGH QUALITY AND COMPATIBLE CLOSED PROFILES
6 STEEL PROFILES + 6 ALUMINIUM PROFILES
= A LIGHT CRANE SOLUTION FOR ALL LIFTING NEEDS**

STEEL PROFILES FOR CRANE RATED CAPACITIES UP TO 2000 KG

The steel profiles come in four sizes, P125, S140, S200 and S260 and are made of high tensile steel, which allows higher stresses and bigger suspension loads. The steel profiles allow 300 kg upward forces when equipped with a SW trolley. The profiles have a world-class weight-load carrying capacity ratio.

All profiles are rolled from one metal sheet to precise tolerances. To ensure the highest quality, the cambering and opening are measured for each profile.

S200 and S260 profiles can be equipped with an internal conductor rail (ICR).

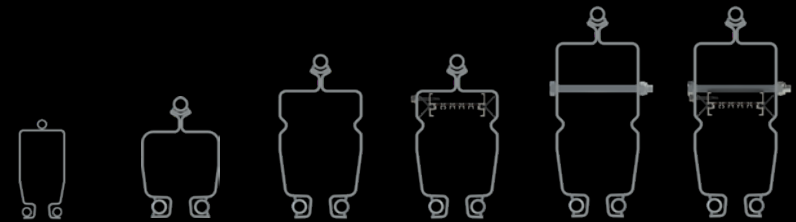

PROFILE	P125	S140	S200	S200 ICR	S260	S260 ICR
PROFILE HEIGHT (mm)	125	140	194	194	254	254
PROFILE WIDTH (mm)	64	100	108	108	108	108
WEIGHT (kg/m)	8,2	12,8	18,1	19,0	22,0	22,9
INTERNAL CONDUCTOR RAIL	No	No	No	Yes	No	Yes



ALUMINIUM PROFILES FOR CRANE RATED CAPACITIES UP TO 1000 KG

Aluminium profiles come in four sizes, Alu 2/105, Alu 3/140, Alu 4/180 and Alu 5/220 and are made of high-quality anodised aluminium. They have an outstanding geometry and can take up to 500 kg upward forces with a standard trolley. The profiles allow smooth and light operation of the hoist and bridge.

The profiles have unique ID stripes to help with identification and installation. Standard profile lengths are 2 m, 3 m, 4 m, 5 m, 6 m, 7 m and 8 m. The profiles Alu 4/180 and Alu 5/220 can be equipped with an internal conductor rail (ICR).

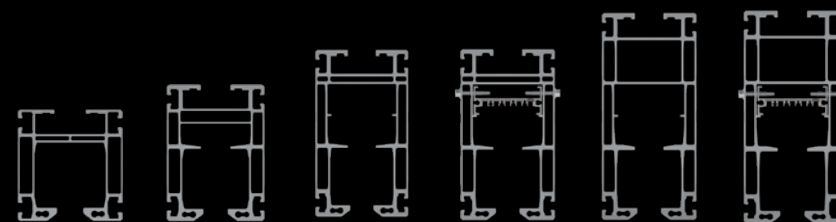

PROFILE	Alu2/105	Alu 3/140	Alu 4/180	Alu 4/180 ICR	Alu 5/220	Alu 5/220 ICR
PROFILE HEIGHT (mm)	105	140	180	180	220	220
PROFILE WIDTH (mm)	96	100	100	100	100	100
WEIGHT (kg/m)	5,1	7,6	9,4	10,3	10,8	11,7
INTERNAL CONDUCTOR RAIL	No	No	No	Yes	No	Yes



UNIQUE STEEL PROFILE JOINT

Chamfered connection tubes are easy and fast to install and ensure lifetime alignment without adjustments. No alignment tools or measurements are needed to connect the profiles. The connection bolts are easy to tighten with an Allen key.

The nuts' shape prevents them from turning in the profile. This connection mechanism allows easy installation even in narrow spaces. The perfectly aligned profile joints allow a smooth and quiet trolley ride over the joint, making the trolley light and easy to move. The profile can be installed in both directions and does not need to be flipped to connect the joint. The design makes the joint fast and easy to install.



SAFETY WITH OVERLOAD INDICATOR

Profile overload indicators are used for single girder cranes, and monorails with rated capacities up to 1000 kg and double girder cranes for over 1500 kg rated capacities. For single girder bridges and monorails, an EGW (external guide wheel) trolley is used instead of a profile overload indicator for rated capacities of more than 1000 kg.

If the load is too heavy, the overload indication is shown as scratch marks outside the profile as the indicator touches the profile.



JOINT SETS FOR ALUMINIUM PROFILES

The aluminium profile joint consists of two connection plates with bolts on both profile sides. This enables a fast and secure installation and a smooth trolley ride over the joint.

There are two joint set sizes. For 500 kg rated capacity or less with four bolts and over 500 kg rated capacity with eight bolts per joint set.

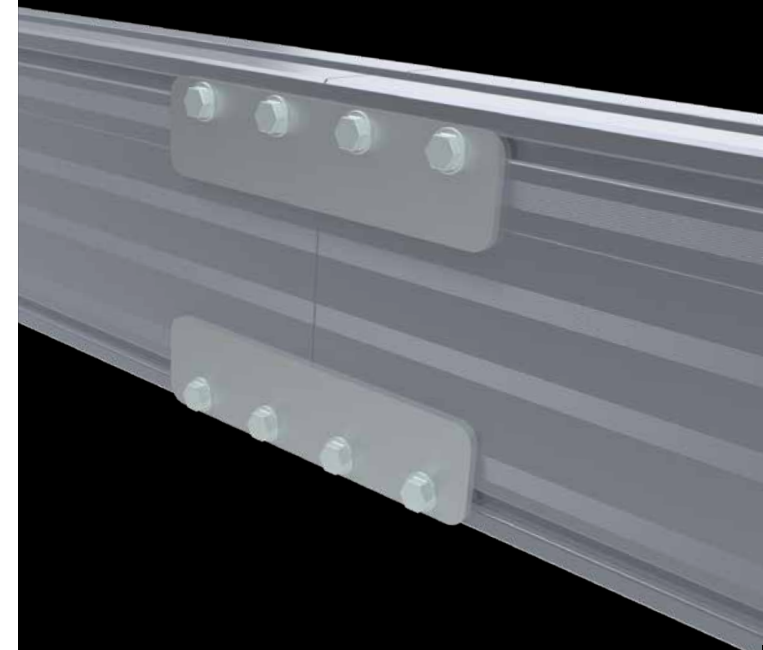

TROLLEYS

TROLLEY FOR STEEL PROFILES

The trolleys are made of pressed steel. They are silent, have minimal rolling resistance and are easy and light to move. There is one trolley for P125 profiles and one that fits all S-profiles (S140, S200, S260).

The maximum load for one trolley is 800 kg, and trolley combinations enable rated capacities up to 2000 kg per system. The trolley has low construction, which for S200 and S260 profiles allows installing a current collector for the internal conductor rail (ICR) power supply above the trolley, giving maximum trolley movement area. The trolley also has an integrated rubber buffer at both ends and side rollers that keep the trolley centred inside the profile.

A trolley with external guide wheels (EGW trolley) is used with single girder bridges and with hoist trolleys when the rated capacity is over 1000 kg to provide a perfectly balanced and smooth trolley movement.



S-trolley (standard)



S-trolley (EGW)



S-trolley (SW)

TROLLEY FOR ALUMINIUM PROFILES

The trolleys for aluminium profiles are made of pressed steel, are silent and have minimal rolling resistance. One trolley fits all aluminium profiles. The maximum load for one trolley is 600 kg, and various trolley combinations enable rated capacities up to 1000 kg.

The trolley has low construction, which for Alu 4/180 and Alu 5/220 profiles allows installing a current collector for the internal conductor rail (ICR) power supply above the trolley. The trolley also has an integrated rubber buffer at both ends.

The eight wheels that run inside the profile make the trolley movements smooth and prevent it from getting stuck. The trolley and profile combination allows up to 500 kg upward forces. Due to this construction, the profile can be assembled upside down, and the trolley can run on top of the profile.



S-bogie



Aluminium trolley

ARTICULATED SUSPENSION

The Prosystem light crane solutions include various standard suspensions to mount the crane. The correct suspension combination for each application can be built from a wide range of standard suspension components for different ceilings, columns, and profile types. The articulation ensures light and ergonomic usage.

A

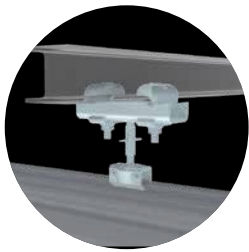

I-BEAM SUSPENSION

B



**FLAT CEILING
SUSPENSION (BOLT-
THROUGH)**

C



SIDE SUSPENSION

D

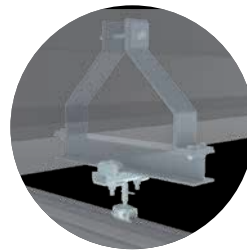

**SHAPED CONCRETE
BEAM SUSPENSION**

E

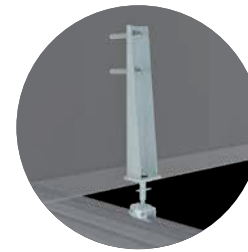

**SIDE SUSPENSION FOR
GLULAM BEAM**

F

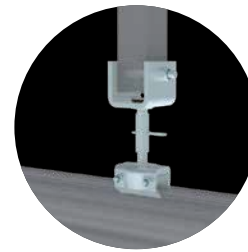

**U-SUSPENSION FOR
RHS PROFILE**

G

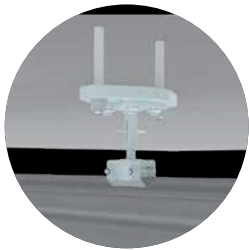

**FLAT CEILING
SUSPENSION
(ANCHORING)**

H

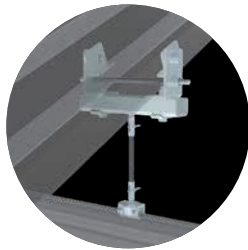

**INCLINED I-BEAM
SUSPENSION**

R

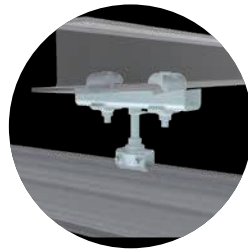

**FIXED I-BEAM
SUSPENSION**

S

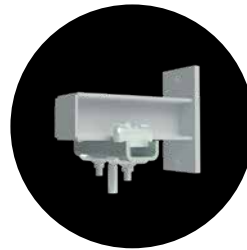

**WALL CONSOLE
SUSPENSION**

AD



**ARTICULATED DOUBLE
SUSPENSION FOR
I-BEAM**

T



**COLLAR SUSPENSION
FOR CEILING BEAM**





KITO ERIKKILA

1000 kg

KITO ERIKKILA

EPAL

FREESTANDING SUPPORT FRAME

A freestanding support frame allows fast and flexible changes in a production line's layout. It's perfect for spaces where the ceiling construction can't carry the crane load. It also allows free use of an overhead crane in the same hall. A freestanding support frame is classified as suspension and not a part of the building.

Specifically designed to handle effortless and precise load movements, the freestanding support frame is easy to install and helps to optimise the working area and improve productivity.

Standard sizes (maximum):

Rated capacity..... 2000 kg
Crane span..... 8 m
Height..... 5 m
Length..... from 4 m
Structure width..... 8,6 m

Other options available as tailored solutions.



POWER

SOPHISTICATED AND LIGHT INTERNAL CONDUCTOR RAIL

The aluminium profiles 4/180R and 5/220R and steel profiles S200 and S260 can be equipped with an internal conductor rail to maximise the crane's coverage. Inside the profile, the power supply is safe from external exposures, allowing full trolley and bridge movements without hanging cables. The internal conductor rail can also be used in curved profiles.

The steel profiles have a small bend in the profile that supports the internal conductor rail. Clips together with a screw drilled through a marked line in the profile secure it in place. The aluminium profiles have a small shelf inside the profile that supports the internal conductor rail. A screw drilled through the profile secures the internal conductor rail.

Because the trolley has low construction, installing a current collector for the internal conductor rail above the trolley is possible. This way, the current collector doesn't restrict the trolley's range of movement.



Current collector guide wheels

Spring-loaded carbon brushes

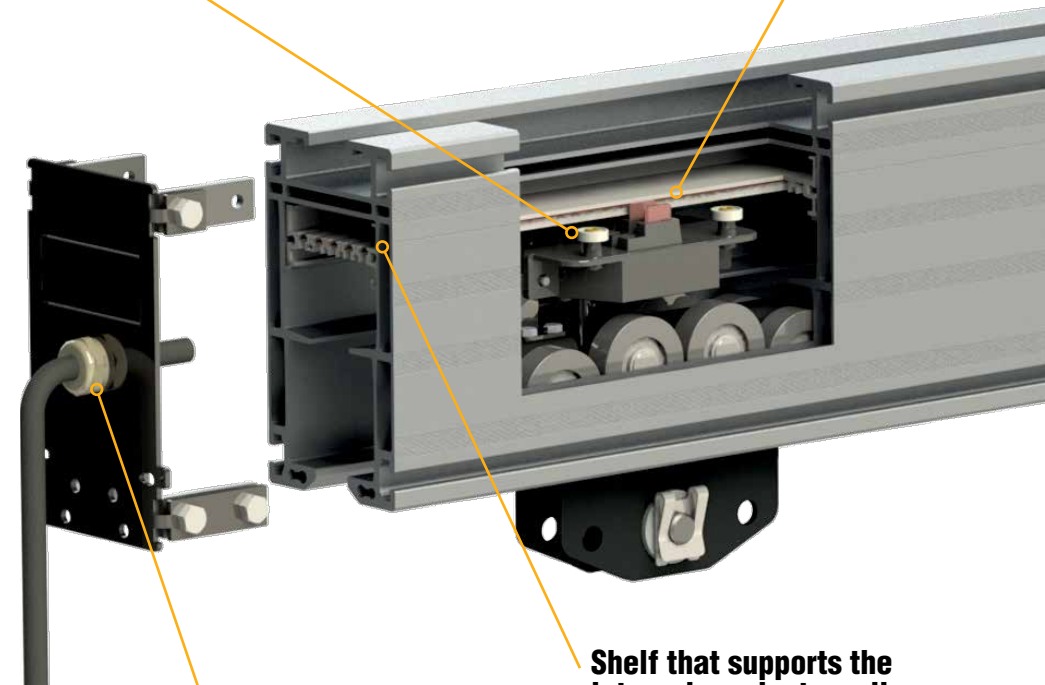

Shelf that supports the internal conductor rail

Power connection cable through a hole in the end plate



FLAT CABLE POWER SUPPLY

All Prosystem light cranes can be equipped with a high-quality flat cable power supply. The flat cable power supply has plastic cable trolleys with plastic wheels running inside the profile, supporting the flat cable. A flat cable power supply can also be used for curved steel profiles.

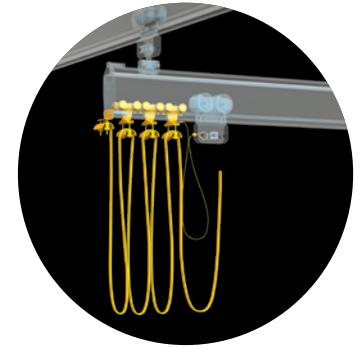

One side of a track can be extended to allow for the accumulation of cable trolleys so that the trolleys do not restrict the working area. An additional stopper ensures the functionality of the crane and keeps the bridge inside the working area.

ELECTRICAL MOVEMENTS FOR TROLLEY AND BRIDGE

Electrical movements for trolley and bridge are recommended if the crane's rated capacity is more than 1000 kg, the lift height is more than 6 m, or the bridge span is longer than 8 m. All electric movements of the trolley and bridge are equipped with limit switches. A crane with electrical trolleys is typically controlled with a radio remote control. The power supply is with an internal conductor rail or flat cable.



Electrical trolleys can be equipped with a lowerable friction wheel to allow manual movements in a power outage or to improve the final positioning accuracy.

TAILORING AND INNOVATION

KITO ERIKKILA offers complete and innovative solutions. Due to its flexible and modular design, the Prosystem light crane can be tailored to almost any lifting needs.



TRACK SWITCH AND CURVE

The track switch and curve connect two monorail tracks with a maximum rated capacity of 1250 kg. It is only available for S200 steel profiles. The trolley can move in both directions through the track switch. The switch has electrical/pneumatic operation with radio control or pendant.



TURNTABLE

The turntable connects several monorail tracks with a maximum rated capacity of 1250 kg. It is only available for S200 steel profiles. The turntable has electrical/pneumatic operation with radio control or pendant.

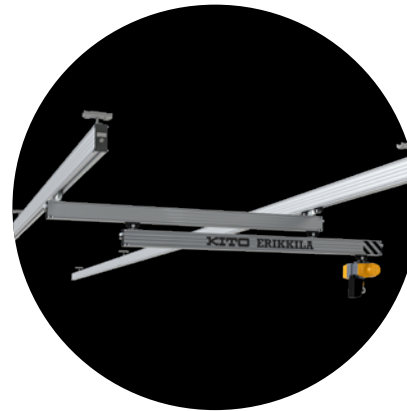

TELESCOPIC CRANE

The telescopic bridge crane lifts loads outside the track. It's available in all sizes of both steel and aluminium profiles. The telescope can be operated manually or it can be motorised with electrical/pneumatic operation using radio control or a pendant.



TRACK LOCK

A track lock connects a bridge crane to a monorail or to another bridge crane to move the load from one crane/monorail to another. The track lock has electrical or pneumatic operation through radio control or pendant. It's available in all sizes of both steel and aluminium profiles.

SUSTAINABILITY AT KITO ERIKKILA

One of our top priorities is to, together with our customers and partners, make lifting and material flow more sustainable. We are constantly working to minimise the waste of resources, energy, and time, both in our factory and in our products.

Our expertise and innovative solutions are the keys to a sustainable business, and we emphasise quality, safety, and sustainability in everything we do.



REFERENCE: EHRLE

Ehrle is the world's leading vehicle washing and cleaning technology provider. To provide seamless and reliable support for all work processes and ensure efficiency in its' assembly plant, Ehrle decided on a smooth-running aluminium light crane system supplied by KITO ERIKKILA. Apart from the cranes' excellent quality and handling, their flexible design was the decisive point for equipping the plant entirely with KITO ERIKKILA light cranes.

“ASSEMBLING KITO ERIKKILA CRANES IS AS EASY AS BUILDING WITH LEGO,”

says delighted EHRLE's Project manager **Sebastian Michaelis**.



REFERENCE: KÄSSBOHRER

Kässbohrer is a manufacturer of Pistenbully vehicles for ski slopes and cross-country trails. Their primary goal was to move from mass production to order-based production. This is why optimisation of the processes was essential.

The positioning of parts and the preparation of components for electric and hydraulic wiring needed to be supported by the light crane solution with exact precision.



REFERENCE: MEYER TURKU

MEYER TURKU OY is one of the world's leading cruise ship builders. The company wanted to bring T-beam production into its' own hands. Meyer compared several light crane suppliers and solutions and chose KITO ERIKKILA based on delivery time and quality.

“THE SCHEDULE FOR THE PROJECT WAS VERY DEMANDING. KITO ERIKKILA MET OUR CHALLENGE WITH A GOOD DELIVERY TIME AND A TECHNICAL SOLUTION THAT SUITED OUR LINE,”

says **Henrik Mantere**, Director of Hull Production.

**“WITHIN JUST A SHORT PERIOD,
ALL THE PROCESSES OF THE NEW
PRODUCTION LINE LITERALLY WENT
LIKE CLOCKWORK,”**

Kässbohrer's Production planner

Philipp Heinen says.



KITO ERIKKILA

KITO ERIKKILA

ERIKKILA OY

Masalantie 225

02430 Masala, Finland

Tel. +358 9 2219 0530

sales@erikkila.com

WWW.ERIKKILA.COM

Distributor:

© ERIKKILA OY

ERIKKILA OY reserves the right at any time to change the products or their details or to discontinue the sale of the products.